

Envirosight



ROVER X

The Power of One

Safe, Easy and Advanced Sewer Inspection Crawler



The Power of One

ROVER X is the one system that lets you do everything—control inspections, view and record digital video, log observations, generate reports, and link directly to asset-management software. All this capability is packed into a simple three-piece layout, with no CCU or other components to clutter your truck.

ROVER X is built on a powerful digital backbone. Not only can you add side-scanning, laser profiling and lateral launch, you can view status from onboard sensors, automate tasks with macros, and measure defects on-screen. And future capabilities are limitless—ROVER X's firmware updates automatically to the latest features and accessory support.

Technology aside, ROVER X is built for the rigors of sewer work. Twelve wheel options—plus camera lift, carriage and lamp accessories—mean ROVER X transforms in seconds to inspect any line. Its steerable six-wheel drive navigates past obstacles, and overlapping wheels climb offsets better than tracks.

ROVER X



ROVVER X

Responsive Controls

Control multiple camera and crawler functions at once. • View live and recorded video directly on controller. • Use macros to automate inspection tasks like joint scanning. • Access specialized functions using intuitive touchscreen interface. • Measure features and defects.



EnviroSight



Visibility

Capture superior video resolution. • Illuminate distant targets with 50% brighter LED light. • Boost illumination in large pipelines with auxiliary lamp. • See above flow with high-mount rear-view camera, plus additional rear-view camera on auxiliary lamp.

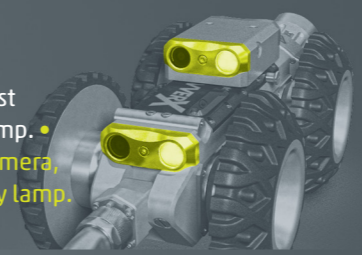

Adaptability

Remotely adjust camera height over 7" range with lift accessory. • Handle pipe of any size, material and condition with 12 wheel options. • Extend height and wheelbase with carriage accessory for pipelines up to 72" diameter.

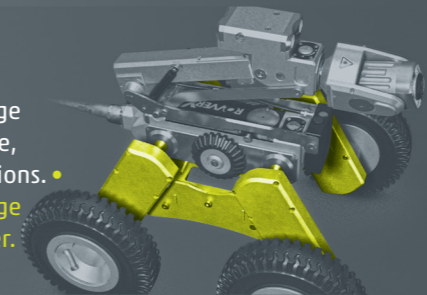

Maneuverability

Control any number of camera and crawler functions at once. • Pivot in place with zero-degree turning. • Use macros to automate tasks (like joint scanning). • Avoid high-centering on offsets and debris with overlapping wheels.

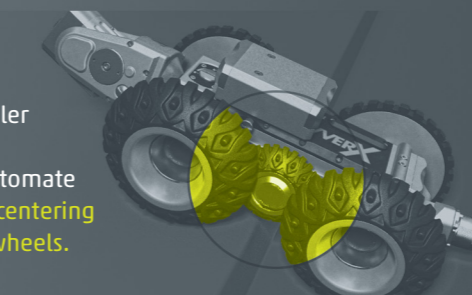

Range

Crawl up to 1000' with standard reel. • Overcome obstacles with unmatched maneuverability and power. • Prevent tangles and maximize range with cable tension control. • Control reel direction, force, speed and mode directly from pendant.

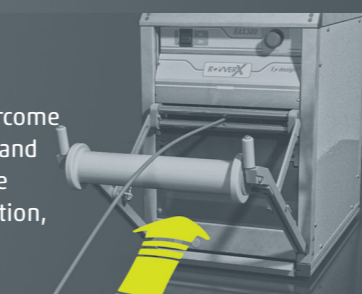

Measurement

Track pipe grade with inclinometer. • Monitor temperature/pressure with onboard sensors. • Locate crawler using built-in sonde. • Easily add laser profiling and side-scanning. • Size defects with twin lasers. • Avoid flips with warnings from roll sensor.

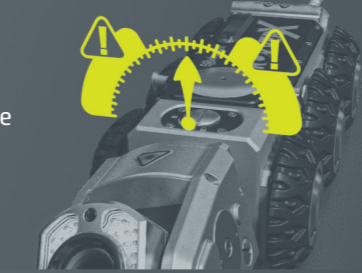

Field-Readiness

Inspect from truck, pickup or ATV using simple 3-component system. • Run off generator or inverter. • Inspect pipelines 6-72" diameter with single, reconfigurable crawler. • Store 1000' of strong, lightweight cable on compact, automated reel. • Transport system in compact, weatherproof enclosure.

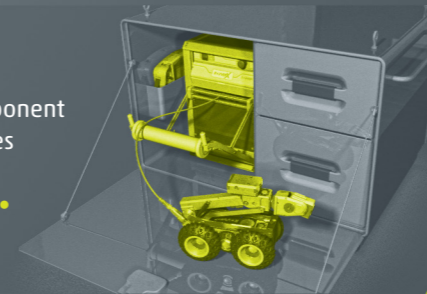

Complete Capability

With many wheel options—plus a detachable lift, carriage and auxiliary lamp—ROVVER X is the only single system that lets you inspect lines 4-96" diameter. With quick-change wheels, you'll be ready in seconds to handle any combination of pipe size, material and condition. (See wheel chart on reverse panel.)

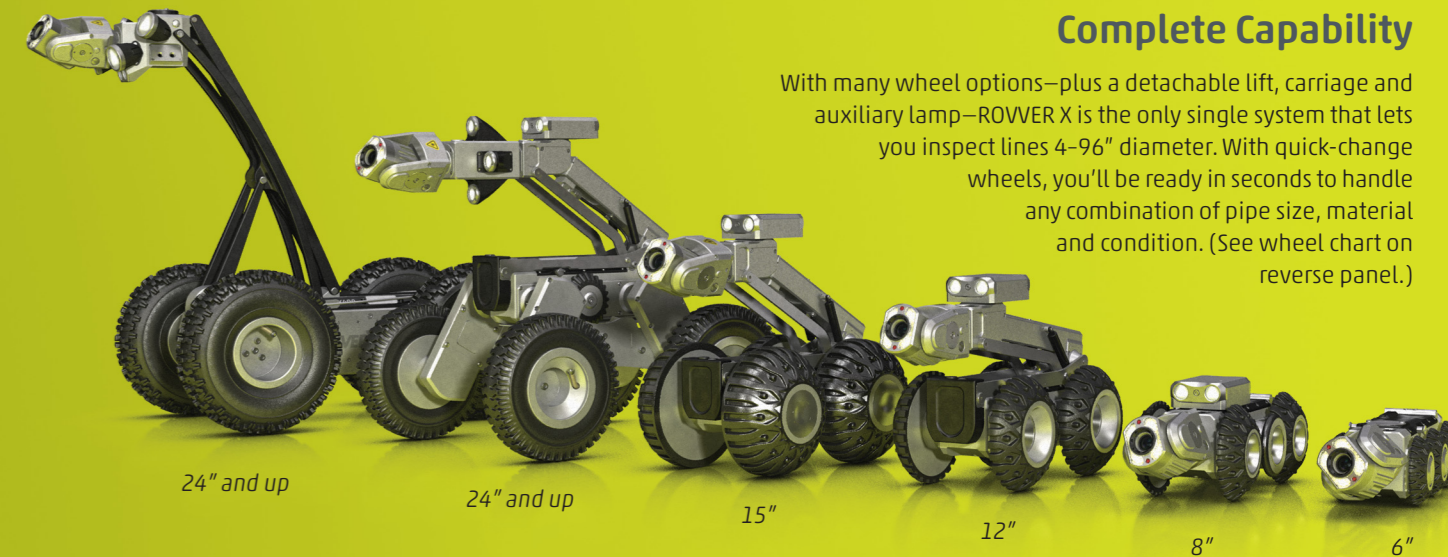

24" and up

24" and up

15"

12"

8"

6"

(down to 4" with available RX 95 crawler body)

Power to Maneuver

ROVVER X was the first crawler with steerable 6-wheel drive, giving operators the ability to navigate past obstacles that stop other crawlers.

ROVVER X adds to that legacy with CAN-bus controls, which allow you to perform multiple functions at once. Now you can steer while panning the camera and adjusting camera lift height. Proportional joysticks give you fine control over speed and direction, and also let you pivot in place.

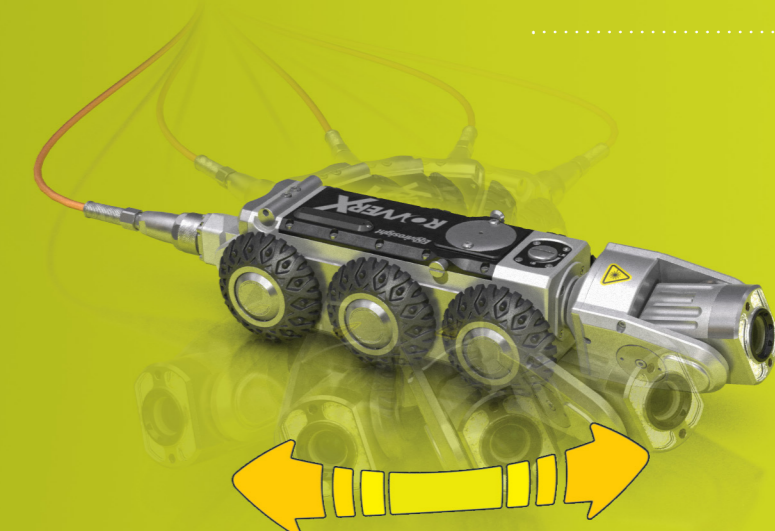

Many Ways to Inspect

► **Digisewer.** Generate side-scans that capture every detail from pipe wall. With Digisewer, you can inspect three times faster than with CCTV—at a cost and learning curve anyone can manage. With the Digisewer laser ring, you can also measure pipe ovality.

► **Laser.** Onboard lasers can be used to measure defects and ovality. With an optional laser profiling accessory attached, WinCan's laser module can track cross-section along the pipe to determine ovality and create a geometric model.

► **Lateral Launch.** The ROVVER X SAT lateral launch add-on lets you inspect laterals from a mainline, ideal for finding gas line cross-bores and illicit flows. It integrates with any existing ROVVER X system, reducing cost and equipment clutter.



Recording

Store digital video and images, and export them via USB media, network port or Wi-Fi. • Review footage directly onscreen.

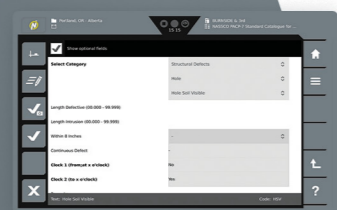

observation entry

Reporting

Log observations on touchscreen. • Use standard or custom defect catalogs. • Generate simple reports, or use WinCan for full reporting. • Overlay text on video without external hardware. • View system status and operating history.



inspection overview



overlay setup

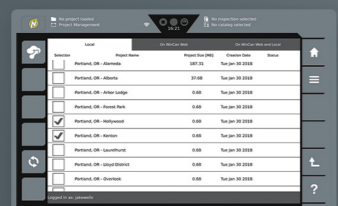

WinCan Web upload

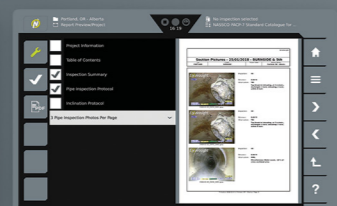

report generation



measurement tools

Remote Control

Supplied standard, this single-channel wireless remote lets you control camera, crawler, lift and reel.



WinCan VX software now comes standard with every ROVVER X system. WinCan VX lets you database your inspections, deliver detailed reports, share projects via the cloud, map your data, and achieve PACP compliance.

And upgrading your license gives you access to: technology modules (Laser, Digisewer, 3D, lateral launch) • enhanced reporting • network installation and enterprise databases (Oracle, SQL) • links to municipal apps (ArcGIS, Hansen, Maximo, CityWorks, GBA, Cartegraph)

Onboard Intelligence

ROVER X uses CAN-bus, the same technology found in modern automobiles. This gives it capabilities not available anywhere else:

Automatic Updates: When connected to the Internet, the pendant updates its firmware automatically, ensuring the latest features.

Concurrent Control: Digital communications let you control any number of camera, crawler and accessory functions at once.

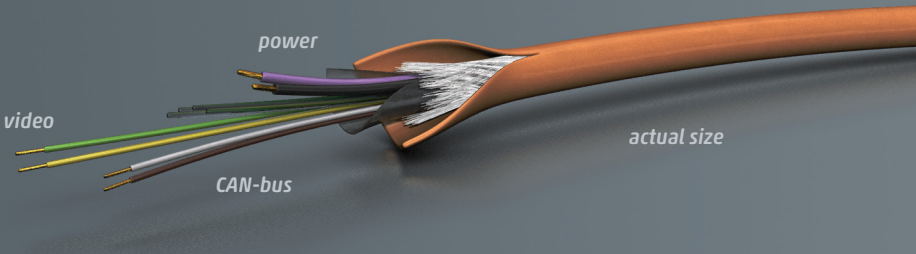

Agility & Uptime: With only six conductors, lightweight ROVER X cable is easy to pull long distances, and also easy to reterminate. Kevlar gives it a 1000-lb. break strength, and a tough jacket maximizes abrasion resistance.

Future-Readiness: ROVER X evolves with technology, which means its capabilities can grow with your needs.

Information: Access system status, from real-time sensor data to lifetime service and operating history.

Self-Diagnostics: Connect to a PC with ROVER X Studio, and our technicians can log in to read error codes and run diagnostics.

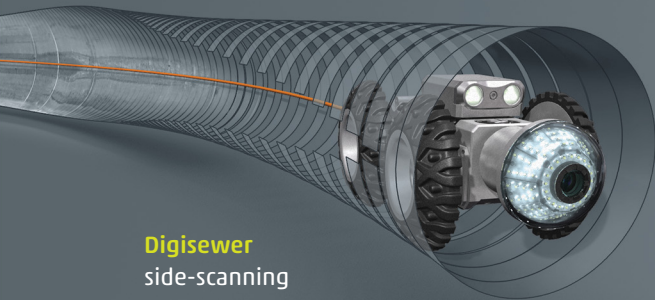

Digisewer
side-scanning

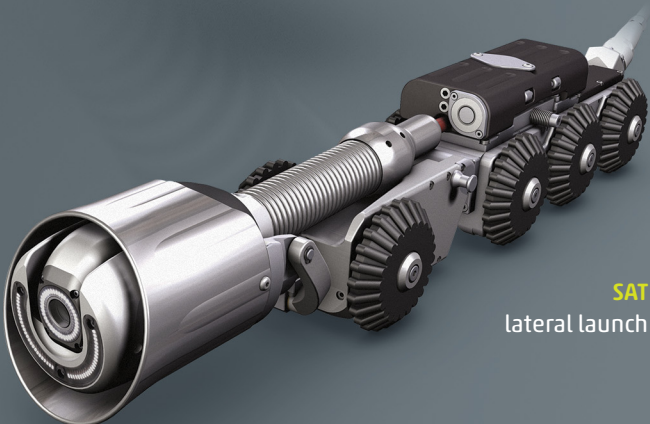

SAT
lateral launch

Quick-Change Wheels

Swapping in seconds with no tools, ROVVER X quick-change wheels address any combination of pipeline diameter, material and condition.

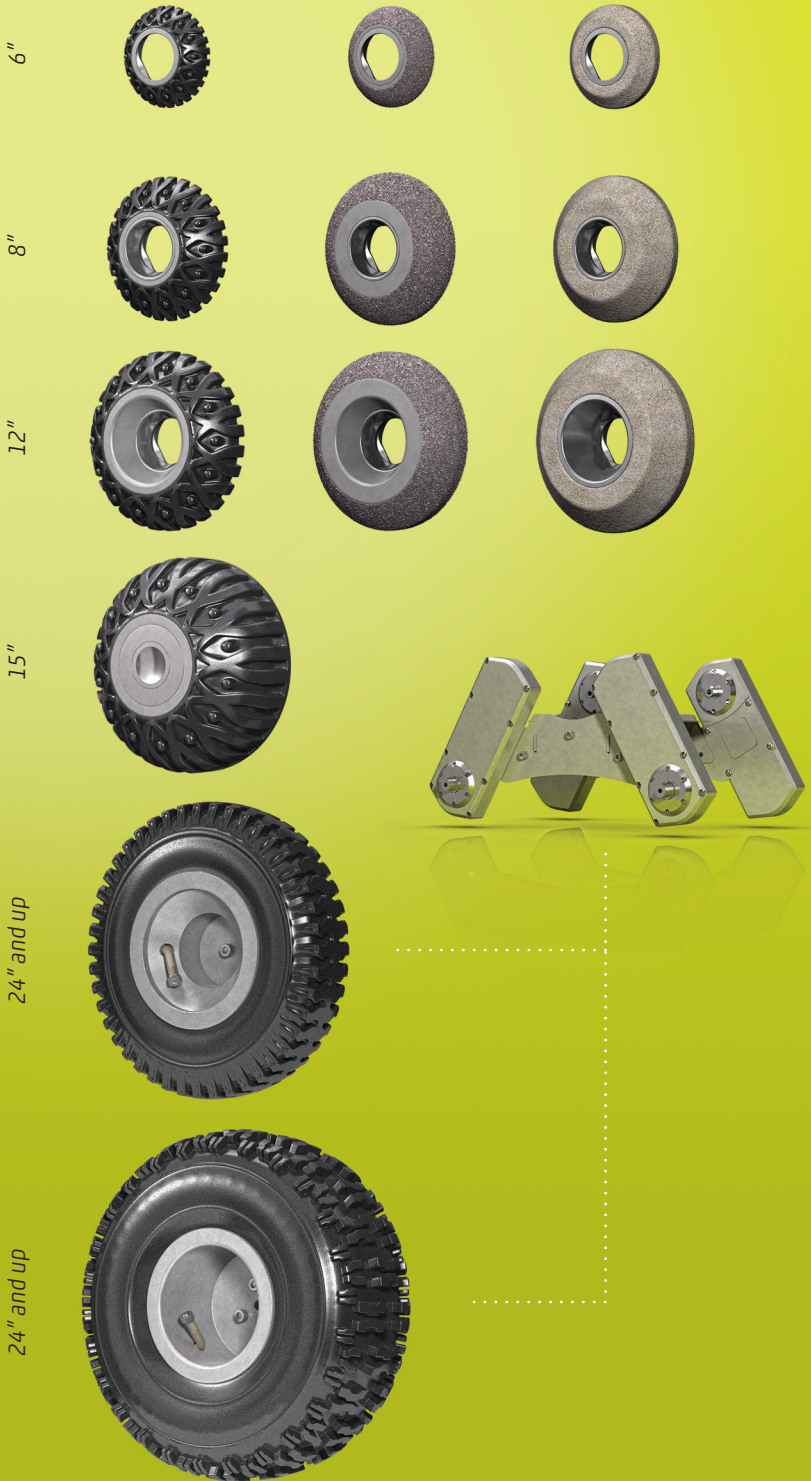

system

ratings CE, NRTL
power 120-240 Vac, 60 Hz
viewing capability pipelines 4-96" dia.

camera (RCX90)

imager color 1/4" CCD
resolution 720 × 576 pixels
zoom lens 120× (10× optical, 12× digital)
pressure rating 1 bar
features auto shutter; auto/manual focus
illumination dimmable 40-LED array
articulation ±145 deg tilt; infinite pan
measurement twin laser diodes
sensing temperature, pressure, pan/tilt
size 6.6" × 3.1" × 2.8" (168 × 81 × 72 mm)
weight 3.3 lb (1.5 kg)
materials aluminum, stainless steel

crawler (RX130)

wheels 6
turn radius down to 0.0"
camera color rear-view with tri-LED lamp
sensors pitch, roll, temperature, pressure
pressure rating 1 bar
size 12.2" × 4.4" × 3.2" (310 × 111 × 90 mm)
weight 13.2 lb (6 kg)
materials aluminum, stainless steel
sonde transmitter 33 kHz / 512 Hz

control pendant (VC500)

controls joysticks, touchscreen, power, stop
touchscreen ... 10.1" color TFT, 1280×800 pixels,
1280 cd/m², 150-deg view angle
video capture MPEG-4 AVC (H.256)
image capture JPEG or PNG
internal storage 32 GB
connectivity ... LAN (RJ45), USB, Wi-Fi, HDMI, BNC
size 11" × 10.5" × 2.8" (280 × 267 × 71 mm)
weight 4 lb (1.81 kg)
housing plastic (ABS, PC), IP55-rated
operating temp 32 to 140°F
storage temp -22 to 158°F

aux. lamp (optional)

lamps four (4) tri-LED lamps
dimensions ... 4.6"×5.2"×5.2" (117×132×132 mm)
materials aluminum, stainless steel



cable reel (RAX300)

cable length 1000' (300 m)
cable diameter 1/4" (6.5 mm)
cable weight 0.03 lb/ft
cable strength 1000 lb
cable conductors 6
controls (local) power, emergency stop
controls (via pendant) auto/manual, speed,
forward/reverse, pull strength
sensors tension, tilt
size 24.2"×12.4"×19.3" (620×315×490 mm)
weight 68.3 lb (31 kg)
connections pendant, service, video in/out

camera lift (optional)

lift range 3.1-10.2" (132-312 mm)
materials aluminum, stainless steel

carriage (optional)

wheelbase (w/l) 14.5"/12.2" (368/310 mm)
weight 34.2 lb (15.5 kg)
materials aluminum, stainless steel

aux. lamp/rear camera (optional)

forward illumination twin tri-LED lamps
camera color rear-view with tri-LED lamp
sonde transmitter 33 kHz / 512 Hz
materials aluminum, stainless steel

basic system

- RX130 crawler body
- RCX90 camera head
- RAX300 reel with 1000' cable
- VC500 control pendant
- WinCan VX software (basic)
- single-channel digital wireless remote control
- small rubber wheels (6)
- medium rubber wheels (4)
- medium grease wheels (4)
- climber wheels (2)
- large rubber wheels (4)
- crawler body transport case
- camera head transport case
- tools (wrenches, pressure kit)

options/accessories

- laser profiler
- Digisewer side-scan camera
- lateral launch crawler/reel
- remote camera lift
- large-pipe carriage
- large- and small-dia. crawlers
- aux. lamp/rear-view camera
- desktop mount for pendant
- USB media for pendant
- wheel sets (see chart on flap)
- cable management accessories
- lowering devices
- WinCan VX software (advanced)
- other accessories



www.envirosight.com

(866) 936-8476

111 Canfield Ave., Unit B3
Randolph, NJ 07869

Regional sales, support and service
across North and South America.

The industry's most
extensive network of
service partners.

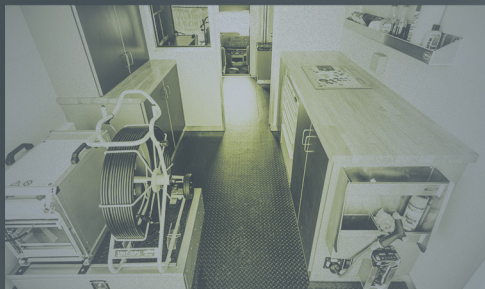

We've analyzed the preferences of our inspection vehicle customers to identify the most popular configurations. We offer these as our Preferred Build-Outs.

We can also build inspection vehicles of any chassis and size, with production facilities on each coast for responsive delivery. We stock select chassis and boxes, and can retrofit new systems into existing trucks.

